

LVW-600

TECHNICAL DATA			Product Code LVW-600
Ratio	Class	VA	
600/5 A	0.5	5	
Specification	DDS:80-2007, IEC 61869		

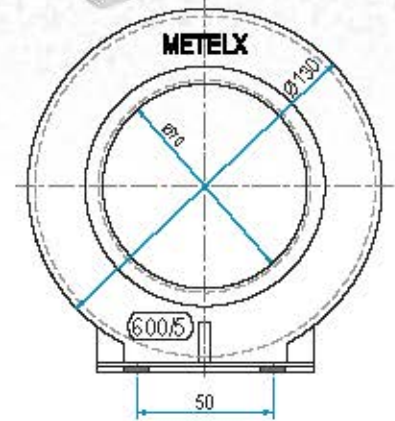
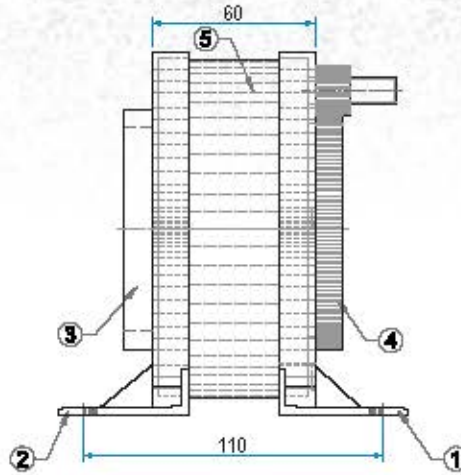
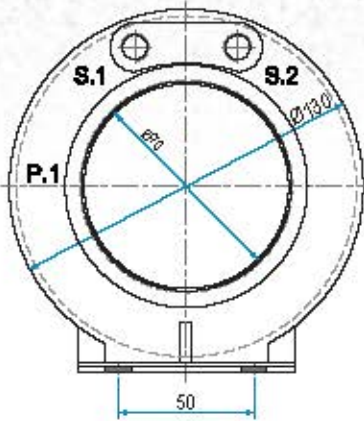

LVW-800

TECHNICAL DATA			Product Code LVW-800
Ratio	Class	VA	
800/5 A	0.5	5	
Specification	DDS:80-2007, IEC 61869		

