

LVW-100

TECHNICAL DATA			Product Code LVW-100
Ratio	Class	VA	
100/5 A	0.5	5	
Specification	DDS:80-2007, IEC 61869		

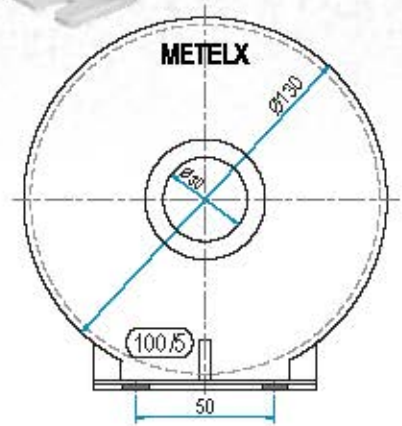
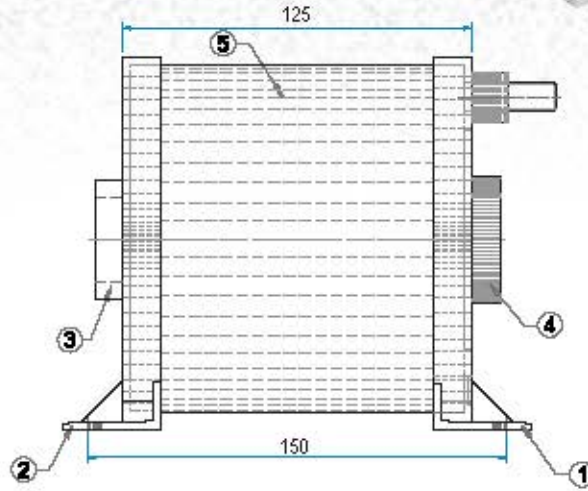
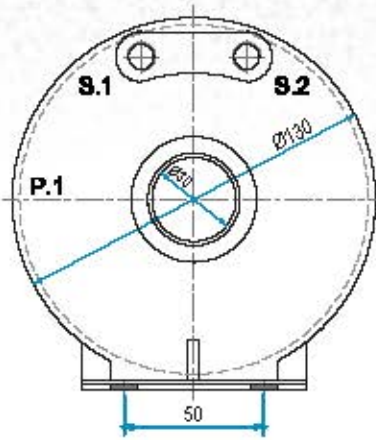

LVW-200

TECHNICAL DATA			Product Code LVW-200
Ratio	Class	VA	
200/5 A	0.5	5	
Specification	DDS:80-2007, IEC 61869		

